

User Guide



Coupon Eligible Converter Box with Analog Pass through

NS-DXA1-APT

Insignia NS-DXA1-APT Coupon Eligible Converter Box with Analog Pass Through

Welcome

Congratulations on your purchase of a high-quality Insignia product. Your NS-DXA1-APT represents the state of the art in coupon eligible converter box design and is designed for reliable and trouble-free performance.

TV Converter Box Coupon Program

You should have already received and applied your coupon towards the purchase of your converter box. However, if you did not, take your receipt and coupon to your local Best Buy and they will apply your coupon.

If you do not have a coupon, you can download one at <https://www.dtv2009.gov/>.

Contents

Welcome	1
TV Converter Box Coupon Program	1
Safety information	1
Introduction to digital TV	2
How do I watch channels still broadcast in analog?	2
Features	3
Package contents	3
Front	3
Back	3
Remote control	4
Setting up your converter box	5
Connecting an antenna	5
Connecting to a VCR or DVD player	5
Setting basic options	5
Using your converter box	6
Turning your converter box on or off	6
Setting the output channel	6
Changing channels	7
Adjusting the volume	7
Searching for channels	7
Adding new channels to the channel list	7
Editing the memorized channel list	8
Creating a Favorites list	8
Manually adding channels	8
Selecting the TV type	9
Selecting the TV program aspect ratio	9
Setting the Sleep timer	10
Displaying the channel banner	10
Using the Simple Guide	10
Viewing TV program information	10
Controlling closed captions	11
Controlling closed captions	11
Turning the lock system on or off	11
Changing the password	11
Blocking channels	12
Blocking children's TV programs	12
Blocking general TV programs	13
Blocking movies	13
Downloading rating information	14
Using the on-screen menu system	14
Programming the converter box remote control	16
Troubleshooting	18
Specifications	18
Legal notices	18
90-day limited warranty	19

Safety information



CAUTION: TO REDUCE THE RISK OF ELECTRIC SHOCK DO NOT REMOVE THE COVER (OR BACK). NO USER-SERVICEABLE PARTS INSIDE. REFER SERVICING TO QUALIFIED SERVICE PERSONNEL.



The lightning flash with arrowhead symbol within a triangle is intended to alert you to the presence of uninsulated dangerous voltage within your converter box's enclosure that may be of sufficient magnitude to constitute risk of electric shock to persons.



The exclamation point within a triangle is intended to alert you to the presence of important operating and maintenance (servicing) instructions in the literature accompanying your converter box.

Warning

To prevent fire or electric shock hazard, do not expose your converter box to rain or moisture.

Warning

Do not install your converter box in a confined space such as a bookcase or similar unit.

Warning

Do not block any ventilation openings. Install in accordance with the manufacturer's instructions. Slots and openings in the cabinet are provided for ventilation and to ensure reliable operation of your converter box and to protect it from overheating.

The openings should be never be blocked by placing your converter box on a bed, sofa, rug, or other similar surface. Your converter box should not be placed in a built-in installation such as a bookcase or rack unless proper ventilation is provided or the manufacturer's instructions have been adhered to.

Caution

Your converter box should not be exposed to water (dripping or splashing) and no objects filled with liquids, such as vases, should be placed on it.

Power cord warning

Most appliances recommend they be placed upon a dedicated circuit—a single outlet circuit which powers only that appliance and has no additional outlets or branch circuits.

Overloaded power outlets, loose or damaged wall outlets, extension cords, frayed power cords, or damaged or cracked wire insulation are dangerous. Any of these conditions could result in electric shock or fire. Periodically examine the cord of your converter box, and if its appearance indicates damage or deterioration, unplug it, discontinue use of your converter box, and have the cord replaced with an exact replacement part by an authorized service personnel.

Protect the power cord from physical or mechanical abuse, such as being twisted, kinked, pinched, closed in a door, or walked upon. Pay particular attention to plugs, wall outlets, and the point where the cord exits your converter box.

To disconnect the main power from your converter box, unplug the power cord from the power outlet. When installing your converter box, make sure that the plug is easily accessible.

- 12 Use only with the cart, stand, tripod, bracket, or table specified by the manufacturer or sold with your converter box. When a cart is used, use caution when moving the cart/converter box combination to avoid injury from tip-over.
- 13 Unplug your converter box during lightning storms or when unused for long periods of time.
- 14 Refer all servicing to qualified service personnel. Servicing is required when your converter box has been damaged in any way, such as when the power cord or plug is damaged, liquid has been spilled or objects have fallen into your converter box, your converter box has been exposed to rain or moisture, does not operate normally, or has been dropped.



Important safety instructions

- 1 Read these instructions.
- 2 Keep these instructions.
- 3 Heed all warnings.
- 4 Follow all instructions.
- 5 Do not use your converter box near water.
- 6 Clean only with a dry cloth.
- 7 Do not block any ventilation openings. Install in accordance with the manufacturer's instructions.
- 8 Do not install near any heat sources such as radiators, heat registers, stoves, or other apparatus (including amplifiers) that produces heat.
- 9 Do not defeat the safety purpose of the polarized plug. A polarized plug has two blades with one wider than the other. The wide blade is provided for your safety. If the provided plug does not fit into your outlet, consult an electrician for replacement of the obsolete outlet.
- 10 Protect the power cord from being walked on or pinched particularly at plugs, convenience receptacles, and the point where they exit from the apparatus.
- 11 Only use attachments or accessories specified by the manufacturer.

Introduction to digital TV

What's digital TV about?

The TV broadcasting industry is in the process of converting from analog TV signals to digital TV signals. The conversion will be complete by February 2009.

A digital TV signal transmits more data than an analog signal. This increase in data provides a better picture and sound with less static and interference.

How will the conversion to digital affect me?

If you use an outside antenna and have an older (analog) TV, you may not be able to receive TV signals after the conversion to digital signals is complete.

To receive digital signals on an analog TV, you need a converter box like the NS-DXA1-APT. Your converter box receives the digital signal from the antenna, then converts the digital signal into analog so your analog TV can display the picture and play the sound.

For more information about the transition to digital TV signals, visit:

- www.fcc.gov/cgb/consumerfacts/digitaltv.html
- www.digitaltips.org
- www.dtvtransition.org
- www.dtvanswers.com

How do I watch channels still broadcast in analog?

The analog pass-through functionality in your digital converter box lets you continue viewing analog channels. If some of the channels in your area are digital and some still analog, connect your converter box, then turn it on to watch digital channels and turn it off to watch analog channels.

Digital sub channels

The increase data capacity of a digital signal lets broadcasters fit several channels into the same bandwidth as an analog signal. Broadcasters may use these sub channels to transmit a variety of information, such as weather forecasts, foreign languages, or commercials.

A digital sub channel is indicated by the main channel number followed by a dash and the sub channel number. For example, 5-1 indicates sub channel 1 of the main channel 5.

Features

Package contents

- RF cable (1)
- Video cable (1)
- Audio (L/R) cable (1)
- Remote control (1)
- Battery (size AAA) (1)
- *Quick Start Guide* (1)
- *User Guide* (1)

Back

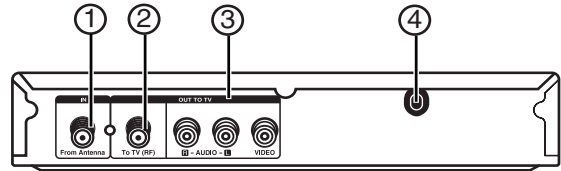

No.	Component	Description
1	From Antenna	Connect this jack to your antenna.
2	To TV (RF)	If your TV does not have A/V jacks, connect this jack to the antenna IN jack on your TV.
3	R AUDIO L AUDIO VIDEO	If your TV has A/V jacks, connect these jacks to the corresponding jacks on your TV. These jacks provide the best audio and video. If your TV does not have A/V jacks, connect your TV to the To TV (RF) jack.
4	Power cord	Plug this cord into a power outlet or surge protector.

Front

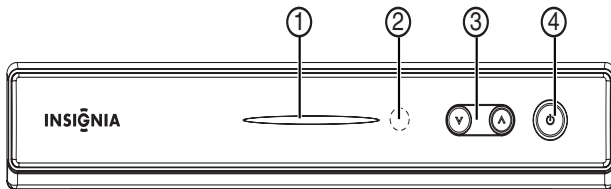

No.	Component	Description
1	Power indicator	Lights when your converter box is turned on. Red—Standby mode Blue—On mode Blinking—Receiving remote control signal
2	Remote control sensor	Receives signals from the remote control. Do not block.
3	∨ / ^	Press to scan through memorized channels.
4	Power	Press to turn your converter box on or off.

Remote control

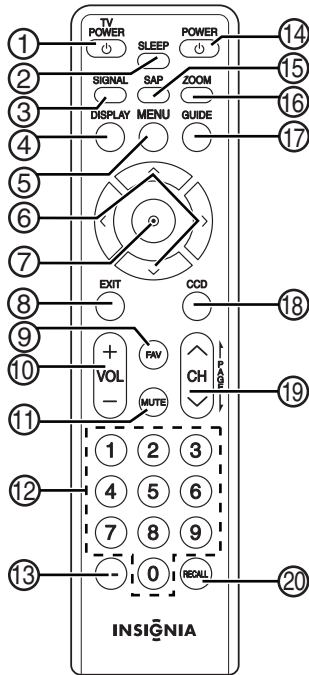

No.	Button	Description
1	TV POWER	Press to turn the TV on or off. For more information, see "Programming the converter box remote control" on page 16.
2	SLEEP	Press to set the Sleep timer. For more information, see "Setting the Sleep timer" on page 10.
3	SIGNAL	Press to view the signal strength for the current channel. You will also hear a series of beeps. The faster the beeps sound, the stronger the signal is.
4	DISPLAY	Press to view information about the program on the current TV channel.
5	MENU	Press to open or close the on-screen menu.
6	^ v > <	Press to highlight options in a menu.
7	● (Select)	Press after you enter a channel number with the button numbers to tune to the channel immediately. In on-screen menus, press to select a highlighted option.
8	EXIT	Press to close any on-screen display or menu and return to normal TV viewing.
9	FAV	Press to select a channel from the Favorites list. For more information, see "Creating a Favorites list" on page 8.
10	VOL+/VOL-	Press to increase or decrease the volume.
11	MUTE	Press to turn off the sound. Press again to restore the sound.
12	Numbers	Press to enter a channel number or parental control password.

No.	Button	Description
13	—	Press to enter a sub channel number. For example, to enter sub channel 1 for the main channel 2, press 2, press this button, then press 1. For more information about sub channels, see "Digital sub channels" on page 3.
14	POWER	Press to turn your converter box on or off.
15	SAP	Press to select a secondary audio program (SAP) for the current TV program.
16	ZOOM	Press to select the aspect ratio.
17	GUIDE	Press to open the Simple Guide. For more information, see "Using the Simple Guide" on page 10.
18	CCD	Press to select the closed caption mode, if available. For more information, see "Controlling closed captions" on page 11.
19	CH ^ / PAGE ↑ CH v / PAGE ↓	Press to go to the next or previous channel, or press to go to the next or previous page in the <i>Channel Edit</i> or <i>Block Channel</i> menu.
20	RECALL	Press to go to the last viewed channel.

Note

If you use a universal remote control, you can use it to control your converter box.
To program the universal remote control to control your converter box, set the remote control's operation mode to Set-Top Box, then set your remote control to the manufacturer codes for LG or Zenith.

Installing the remote control battery

To install the remote control battery:

- 1 Remove the battery compartment cover on the back of the remote control.
- 2 Insert one AAA battery into the battery compartment. Make sure that the + and - on the battery align with the + and - in the battery compartment.

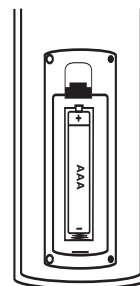

- 3 Replace the battery compartment cover.

Setting up your converter box

Connecting an antenna

Note

If you need information about the type of antenna you should use in your area, visit www.antennaweb.org on the Internet.

To connect your converter box to an antenna:

- 1 Disconnect the coaxial cable from the **Antenna IN** jack on the back of the TV.
- 2 Connect the coaxial cable to the **From Antenna** jack on the back of your converter box.

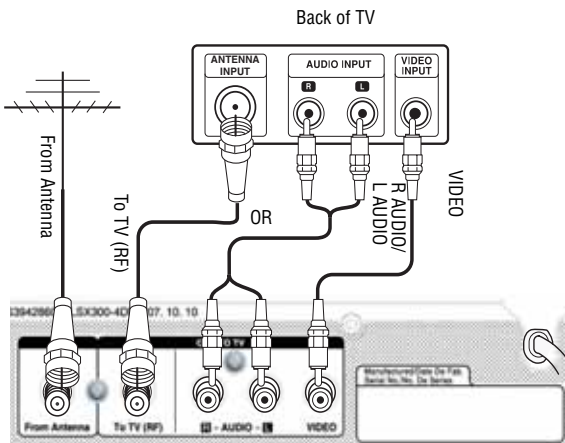

Back of converter box

- 3 Connect the supplied audio cable to the **R AUDIO** and **L AUDIO** jacks on the back of your converter box, connect the supplied video cable to the **VIDEO** jack on the back of your converter box, then connect the other ends of the cables to the corresponding jacks on the back of the TV. This connection provides the best picture and sound.

Or

Connect the supplied coaxial cable to the **To TV (RF)** jack on the back of your converter box, then connect the other end of the cable to the **Antenna IN** jack on the back of the TV. For best performance with this connection, change the **Audio Output** option to **Mono**. For more information, see "OPTION menu" on page 15.

- 4 Plug the power cord into a power outlet or surge protector. The light on the box turns red.
- 5 Turn on the TV and set the TV to the appropriate video source if you used the audio and video cables to connect your converter box to the TV. (For more information, see the TV's documentation.)

Or

Tune the TV to channel **3** if you used the coaxial cable to connect your converter box to the TV.

Note

If you connected the TV with a coaxial cable, set the **Audio Output** option to **Mono**.

When your converter box is turned off, the signal from the **From Antenna** jack is sent through the **To TV (RF)** jack to your TV or monitor.

Connecting to a VCR or DVD player

Note

TiVo® does not support converter boxes, only set-top satellite and cable boxes. If you have a cable or satellite set-top box that you want to connect to your TiVo, you can use an IR-blaster to send signals from the TiVo to the set-top box to change channels so that you are on the correct channel to record.

You can connect your converter box to a video device, such as a VCR or DVD player, then connect the VCR or DVD player to the TV.

Note

If you have a VCR connected to the TV to record TV programs, you must set the channel on the converter box to the TV channel you want to record.

If you have programmed recordings set up, you must set the channel on the converter box to the TV channel for the programmed recording before the start of each recording session.

To connect a video device:

- 1 Disconnect the coaxial cable that goes from the antenna connection to the video device, if connected.
- 2 Connect the coaxial cable from the antenna connection to the **From Antenna** jack on the back of your converter box.
- 3 Connect the supplied audio cable to the **R AUDIO** and **L AUDIO** jacks on the back of your converter box, connect the supplied video cable to the **VIDEO** jack on the back of your converter box, then connect the other ends of the cables to the corresponding jacks on the back of the video device.
- 4 Depending on the type of AV jacks on the video device and the TV, connect the **Audio** and **Video OUT** jacks on the video device to the **Audio** and **Video IN** jacks on the TV.
- 5 Plug the power cord into a power outlet or surge protector. The light on the box turns red.
- 6 Turn on the TV and set the TV to the appropriate video source. (For more information, see the TV's documentation).

Setting basic options

Note

If you connected the TV to the **To TV (RF)** jack, the TV must be tuned to channel **3**. Otherwise, you will not see a picture.

When you turn on your converter box for the first time, the *Install Guide* opens where you can:

- Select the menu language
- Select the TV aspect ratio
- Search for and memorize channels
- Select the time zone

To set basic options:

- 1 Turn on your converter box and TV. The *WELCOME* screen opens.

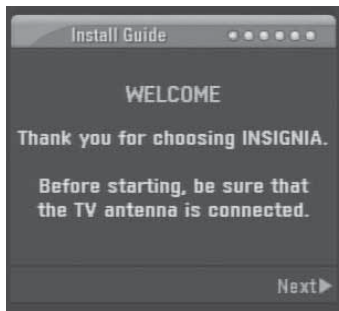

- 2 Press >. The *Menu Language* screen opens.

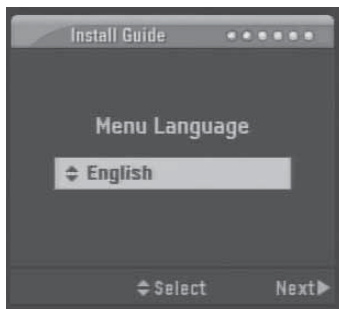

- 3 Press ^ or v to select the menu language (**English**, **Spanish**, or **French**), then press >. The *TV Aspect Ratio* screen opens.



- 4 Press ^ or v to select the aspect ratio for your TV, then press >. If the TV has a standard (normal) size screen, select **Normal TV**. If the TV has a wide size screen, select **Wide TV**. The *Searching for Channels* screen opens.

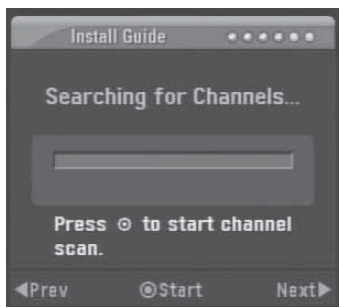

- 5 Press ● to start the channel search. Your converter box searches for available channels in your area and stores them in memory.

- 6 When the search is complete, press >. The *Time Zone* screen opens.

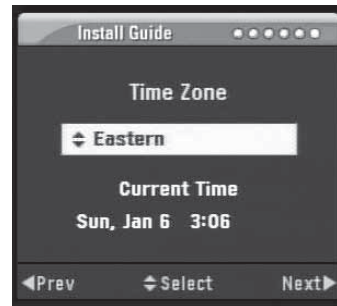

- 7 Press ^ or v to select a time zone, then press >. The *THANK YOU* screen opens.

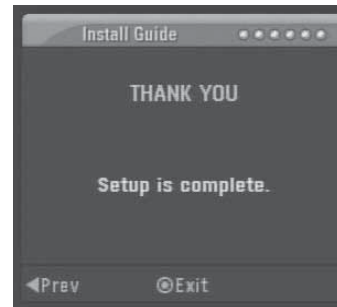

- 8 Press ● to complete the setup and close the Install Guide.

Using your converter box

Turning your converter box on or off

To turn your converter box on or off:

- 1 Make sure that the TV is connected to your converter box and that the TV and your converter box are plugged into power outlets.
- 2 Press **POWER**. The power LED lights.
 - Red—Standby mode
 - Blue—On mode
 - Blinking—Receiving remote control signal
- 3 If this is the first time you have turned on your converter box, follow the on-screen prompts to set basic options. For more information, see “Setting basic options” on page 5.
- 4 To turn off your converter box, press **POWER** again.

Setting the output channel

If the TV is connected through the **To TV (RF)** jack, you need to set the output channel for the TV signal. The TV must be tuned to the same channel as output channel.

To set the output channel:

- 1 Press **MENU**. The *SETUP* menu opens.



- 2 Press **^** or **v** to select **Output Channel**, then press **>** or **o**.
- 3 Press **^** or **v** to select channel **3** or **4**, then press **o**.

Changing channels

Note
You must use the remote control that came with your converter box or program your existing universal remote control to work with your converter box. For instructions, see "Programming the converter box remote control" on page 16.

To change channels:

- Press **CH ^** or **CH v** to select a channel in the memorized channel list.
- Press the number buttons for the channel you want. If you want a digital sub channel, press the number buttons for the main channel, press **-**, then press the number for the sub channel. For more information about sub channels, see "Digital sub channels" on page 3.

When you use the number buttons to select a channel, the Channel List appears. Press **^** or **v** to select the channel, then press **o**.



- Press **RECALL** to return to the last channel you were watching.
- Press **FAV** to select a channel from the Favorites list.

Adjusting the volume

To adjust the volume:

- Press **VOL +** or **VOL -** to increase or decrease the volume.
- Press **MUTE** to turn off the sound. Press **MUTE** again to restore the sound.

Warning
If the volume is set too high when you press **MUTE** to restore the sound, you may damage your hearing or the TV speakers.

Note
For best performance, set the volume control on the TV to mid-range, then use the converter box remote control to adjust the volume.

Searching for channels

Your converter box searched for available channels the first time you turned it on. If you move your converter box to a new TV viewing area, move your antenna, or if the available channels change, you can search for channels again.

To search for channels:

- 1 Press **MENU**. The *SETUP* menu opens.

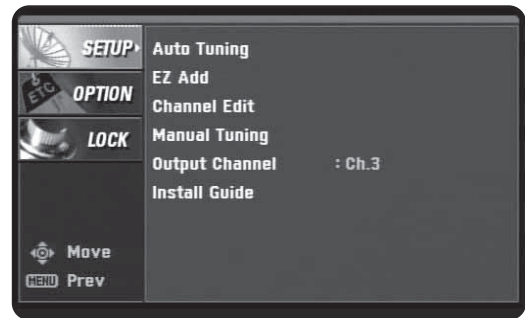

- 2 Press **>**, then press **^** or **v** to select **Auto Tuning**, then press **o** to start the search. Your converter box searches for available channels and stores the channel information in the memorized channel list.

Adding new channels to the channel list

If new channels become available after the initial search for channels or if you move your antenna to tune additional channels, your converter box can search for the added channels and add the channel information to the memorized channel list.

To add channels to the memorized channel list:

- 1 Press **MENU**. The *SETUP* menu opens.

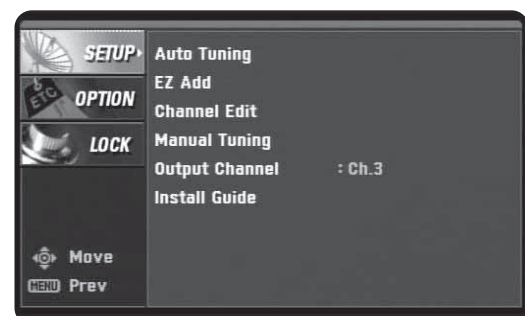

- 2 Press **>**, press **^** or **v** to select **EZ Add**, then press **⊙** to start the search. Your converter box searches for new channels and stores the channel information in the memorized channel list.

Manually adding or deleting channels

To manually add or delete channels:

- 1 Press **MENU**. The *SETUP* menu opens.



- 2 Press **>**, press **^** or **v** to select **Manual Tuning**, then press **>** or **⊙**.
- 3 Select the channel you want to add or delete, then press **⊙**.
- 4 Repeat Step 2 and Step 3 to add or delete more channels.

Editing the memorized channel list

After you create the memorized channel list, you can add or delete channels from the list.

To edit the memorized channel list:

- 1 Press **MENU**. The *SETUP* menu opens.

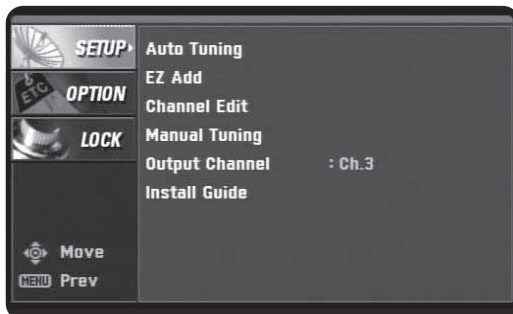

- 2 Press **^** or **v** to select **Channel Edit**, then press **>** or **⊙**. The *Channel Edit* menu opens.
- 3 Select the channel you want to add or delete, then press **⊙**.
- 4 Repeat Step 3 to add or delete more channels.

Creating a Favorites list

To create a Favorites list:

- 1 Press **MENU**. The *SETUP* menu opens.

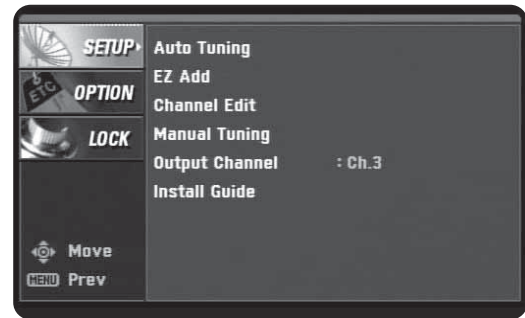

- 2 Press **>**, press **^** or **v** to select **Channel Edit**, then press **>** or **⊙**. The *Channel Edit* menu opens.
- 3 Select the channel you want to add or delete, then press **FAV**. The channel is added to the Favorites list. When you are watching TV, you can tune to a favorite channel by pressing the **FAV** button and selecting a channel from the list.

Manually adding channels

If you need to add a channel that was not found during the channel search, you can add the channel manually.

To manually add channels:

- 1 Press **MENU**. The *SETUP* menu opens.



- 2 Press **>**, then press **^** or **v** to select **Manual Tuning**, then press **>** or **⊙**. The *Channel Edit* menu opens.
- 3 Select the channel you want to add, then press **⊙**.
- 4 Repeat Step 3 to add more channels.

Setting the clock

Normally, your converter box uses time signals sent from DTV channels to automatically set the clock. If the time is not set automatically, you can set the clock by selecting the time zone.

To set the clock:

- 1 Press **MENU**. The menu system opens.



- 2 Press \wedge or \vee to select **Option**, then press \gt or \odot . The *Option* menu opens.



- 3 Press \wedge or \vee to select **Clock**, then press \gt or \odot .
- 4 Press \lt or \gt to select the time zone, then press \vee to select **Day Light Saving**.
- 5 Press \lt or \gt to select **On**, **Off**, or **Auto**. If you select **Auto**, your converter box uses time signals from DTV channels to determine the correct setting.

Selecting the TV type

You set the TV type (aspect ratio) the first time your turned on your converter box. You can change the TV type, if necessary.

To select the TV type:

- 1 Press **MENU**. The *SETUP* menu opens.



- 2 Press \wedge or \vee to select **OPTION**, then press \gt or \odot . The *OPTION* menu opens.



- 3 Press \wedge or \vee to select **TV Aspect Ratio**, then press \gt or \odot .
- 4 Press \wedge or \vee to select channel **4:3** (standard TV screen) or **16:9** (wide-screen TV screen), then press \odot .

Selecting the TV program aspect ratio

You can select the aspect ratio for the current TV program.

Note

If the aspect ratio is set by the program and cannot be changed, this option will be grayed and display the message "Set by Program."

To select the TV program aspect ratio:

- 1 Press **MENU**. The *SETUP* menu opens.



- 2 Press \wedge or \vee to select **OPTION**, then press \gt or \odot . The *OPTION* menu opens.

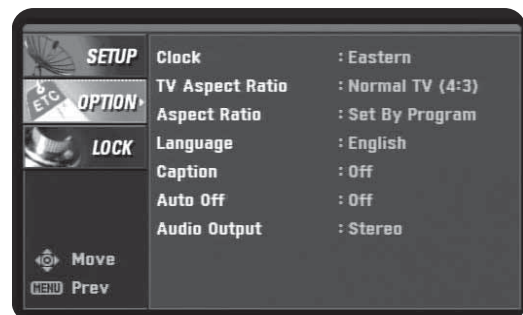

- 3 Press \wedge or \vee to select **Aspect Ratio**, then press \gt or \odot .
- 4 Press \wedge or \vee to select an aspect ratio, then press \odot . The options you can choose vary, depending on the TV type you selected.

Setting the Sleep timer

To set the Sleep timer:

- Press **SLEEP** one or more times to select the amount of time you want your converter box to wait before it turns off the TV. You can select **1 to 4** hours.
- To turn off the Sleep timer, press **SLEEP** one or more times until **Off** appears.

Displaying the channel banner

The channel banner appears briefly when you change channels. The channel banner shows the channel number, station name, current time, and blocked channel information. You can view the channel banner while you are watching a channel.

To display the channel banner:

- 1 Press **⊙**. The channel banner opens.



- 2 Press **⊙** again to close the banner.

Note

The station name and time are displayed only if the station provides the information. Block information includes information such as **No Signal**, **Rating Blocked**, or **Channel Blocked**.

Using the Simple Guide

You can use the Simple Guide to view information for the current or next program.

To use the Simple Guide:

- 1 Press **GUIDE**. The *Simple Guide* opens.

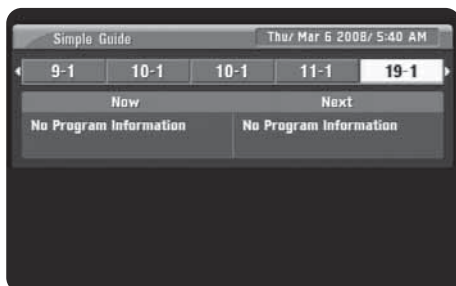

- 2 Press **<** or **>** to view information for another channel.

- 3 If you want to change to another channel, press **<** or **>** to select the channel, then press **⊙**.

Note

The channel information displayed depends on the information provided by the broadcaster. Channel information can only be received from the broadcaster if your TV converter box is tuned to the channel. For example:

If you are watching a channel and open the Simple Guide, information for that channel appears.

If you surf through several channels then open the Simple Guide, information for all the channels you surfed appears.

If you surf through channels then watch a specific channel for an extended amount of time, no information may appear because the information in the Simple Guide has expired. To see channel information in the Simple Guide, retune to the channel.

Viewing TV program information

To display program information:

- Press **DISPLAY**. Information for the program you are watching appears.

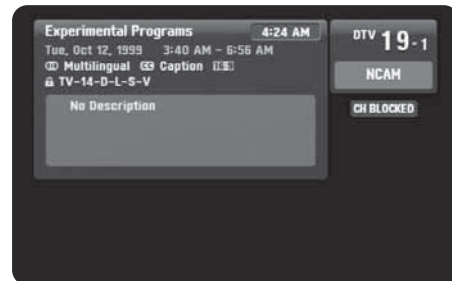

The display contains:

- Program title
- Current date
- Program starting and ending time
- Current time
- Channel number.
- Station name
- Multilingual icon (∞) if the program has multiple languages. Press **SAP** to select a different language.
- Aspect ratio icon (⊞ or ⊞) that indicates the program's aspect ratio. Press **ZOOM** to change the aspect ratio.
- Closed caption icon (CC) if the program has closed captions.
- Content advisory icon (⚠) if the program contains content advisory information. The program's rating value also appears.
- Program details provided by the broadcaster.

Controlling closed captions

You can turn closed captions on or off, select analog or digital closed captions, and change the appearance of digital closed captions.

To turn closed captions on or off:

- 1 Press **MENU**. The *SETUP* menu opens.



- 2 Press \wedge or \vee to select **OPTION**, then press $\>$ or \odot . The *OPTION* menu opens.

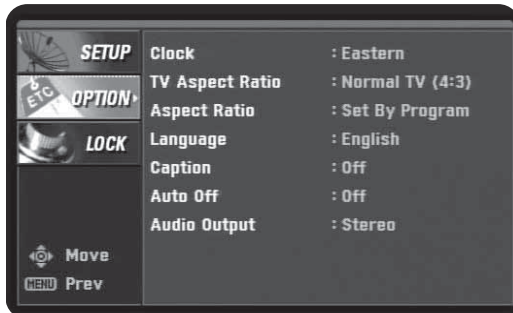

- 3 Press \wedge or \vee to select **Caption**, then press $\>$ or \odot . The *Caption* menu opens.
- 4 Press \wedge or \vee to select **Mode**, then press \leftarrow or \rightarrow to select **Off**, **Digital**, or **Analog**.
 - **Off**—Turns closed captions off.
 - **Analog**—**CC1** through **CC2** display program dialog. **Text 1** through **Text 4** display information provided by the broadcaster.
 - **Digital**—**Service 1** through **Service 6** display languages provided by the broadcaster.
- 5 Press \odot to confirm your selection.
- 6 To change digital closed caption styles, press \wedge or \vee to select **Digital Option**, then press $\>$ or \odot .
- 7 Press $\>$ repeatedly until the closed caption options appear, \wedge or \vee to select an option. A preview of the change appears under the menu window.

You can change the following closed caption options:

- **Style**—Lets you use the program's default caption style or customized styles.
- **Size**—Selects the font size.
- **Text Color**—Selects the font color.
- **Text Opacity**—Selects the font opacity.
- **Bg.**—Selects the background color
- **Bg. Opacity**—Selects the background opacity.
- **Edge Type**—Selects the edge type.
- **Edge Color**—Selects the edge color.

Turning the lock system on or off

Your converter box has a lock system that lets you lock (block) channels you do not want your children to watch. When you try to tune to a locked channel, you must enter the password before you can view the channel.

To turn the lock system on or off:

- 1 Press **MENU**. The *SETUP* menu opens.

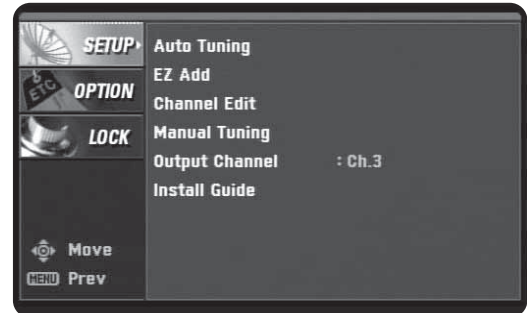

- 2 Press \wedge or \vee to select **LOCK**, then press $\>$ or \odot .
- 3 Press the number buttons to enter the password. If this is the first time you have accessed the lock system, enter the default password **7777**. The *LOCK* menu opens.

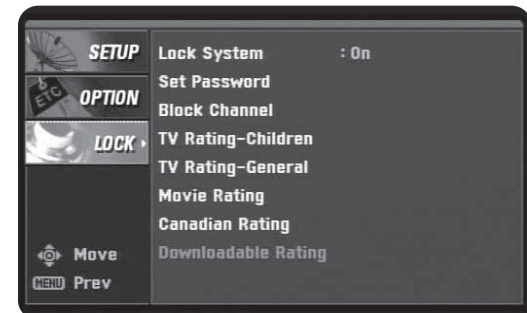

- 4 Press \wedge or \vee to select **Lock System**, then press $\>$ to select **On** or **Off**.

Changing the password

To change the password:

- 1 Press **MENU**. The *SETUP* menu opens.



- 2 Press \wedge or \vee to select **LOCK**, then press $\>$ or \odot .

- Press the number buttons to enter the password. If this is the first time you have accessed the lock system, enter the default password **7777**. The **LOCK** menu opens.

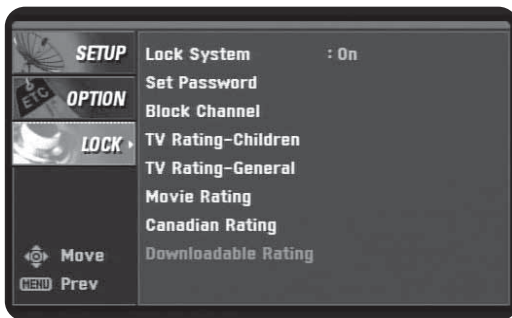

- Press **^** or **v** to select **Set Password**, then press **>** or **●**.
- Press the number buttons to enter a new four-digit password, then enter the new password again.

Blocking channels

You can block channels that you do not want to view. If you tune to a blocked channel, a blinking **CH BLOCKED** banner appears.

To block channels:

- Press **MENU**. The **SETUP** menu opens.



- Press **^** or **v** to select **LOCK**, then press **>** or **●**.
- Press the number buttons to enter the password. If this is the first time you have accessed the lock system, enter the default password **7777**. The **LOCK** menu opens.

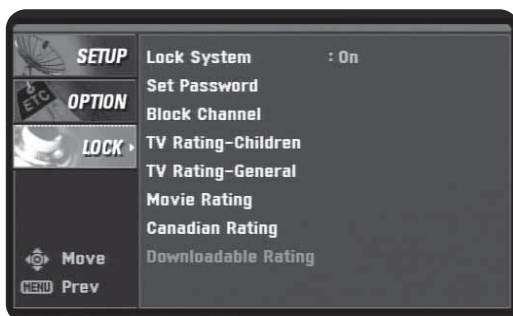

- Press **^** or **v** to select **Block Channel**, then press **>** or **●**.
- Select a channel, then press **●**. A locked icon **🔒** appears next to a blocked channel.
- Repeat Step 4 to block or unblock additional channels.

Blocking children's TV programs

Note

This option does not block programs intended for more mature audiences. To block these type programs, you must use the **TV Rating-General** option. For more information, see "Blocking general TV programs" on page 13.

To block children's TV programs:

- Press **MENU**. The **SETUP** menu opens.

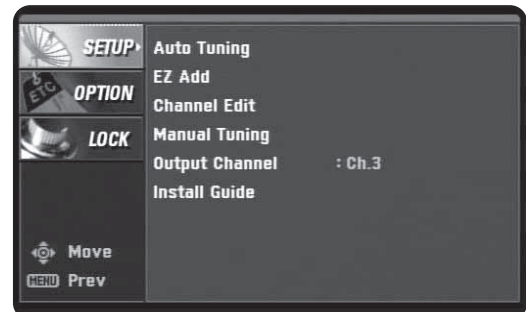

- Press **^** or **v** to select **LOCK**, then press **>** or **●**.
- Press the number buttons to enter the password. If this is the first time you have accessed the lock system, enter the default password **7777**. The **LOCK** menu opens.

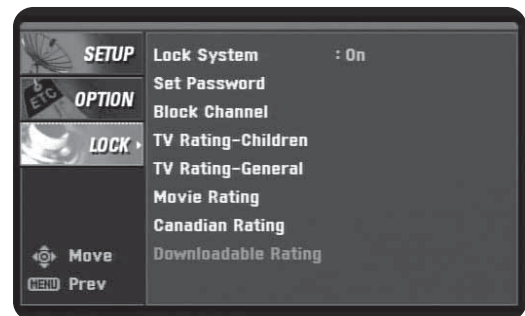

- Press **^** or **v** to select **TV Rating-Children**, then press **>** or **●**.
- Press **^** or **v** to select **Age** or **Fantasy Violence**, then press **>** or **●**.
 - Age**—Applies regardless of the content category rating. After you select **Age**, select **TV-Y** or **TV-Y7**.
 - Fantasy Violence**—Blocks programs that have a fantasy violence rating.
- Press **^** or **v** to select a rating, then press **●**.
 - TV-Y**—Blocks all children's programs.
 - TV-Y7**—Blocks children's programs that are rated TV-Y7 (for children 7 and older).

Blocking general TV programs

To block general TV programs:

- 1 Press **MENU**. The *SETUP* menu opens.

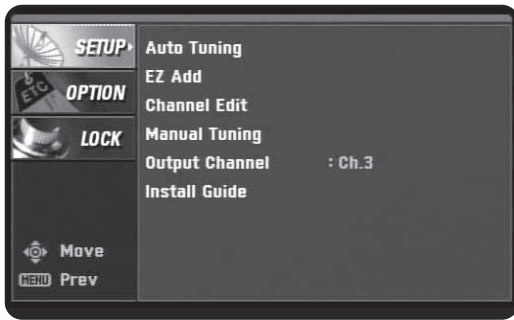

- 2 Press \wedge or \vee to select **LOCK**, then press $\>$ or \odot .
- 3 Press the number buttons to enter the password. If this is the first time you have accessed the lock system, enter the default password **7777**. The *LOCK* menu opens.

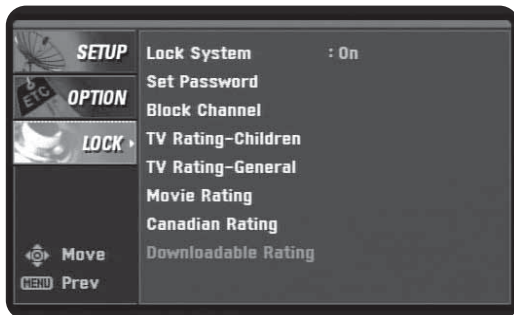

- 4 Press \wedge or \vee to select **TV Rating-General**, then press $\>$ or \odot .
- 5 Press \wedge or \vee to select a content rating, then press $\>$ or \odot .
 - **Age**—Applies regardless of the content category rating. After you select **Age**, select **TV-Y** or **TV-Y7**.
 - **Dialogue**—Blocks programs that have a suggestive dialog rating.
 - **Language**—Blocks programs that have a strong language rating.
 - **Sex**—Blocks programs that have a sexual content rating.
 - **Violence**—Blocks programs that have a violence content rating.
- 6 Press \wedge or \vee to select a rating, then press \odot .
 - **TV-G**—Blocks programs rated TV-G (general audiences).
 - **TV-PG**—Blocks programs rated TV-PG (parental guidance suggested).
 - **TV-14**—Blocks programs rated TV-14 (parental guidance strongly suggested).
 - **TV-MA**—Blocks programs rated TV-MA (mature audiences only).

Blocking movies

To block movies:

- 1 Press **MENU**. The *SETUP* menu opens.

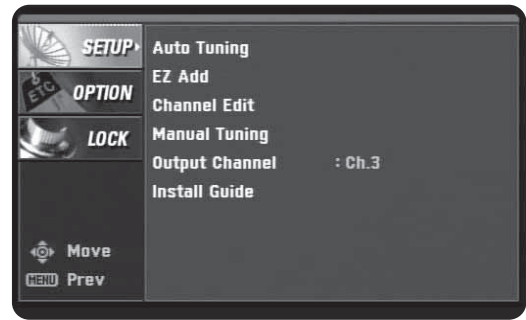

- 2 Press \wedge or \vee to select **LOCK**, then press $\>$ or \odot .
- 3 Press the number buttons to enter the password. If this is the first time you have accessed the lock system, enter the default password **7777**. The *LOCK* menu opens.

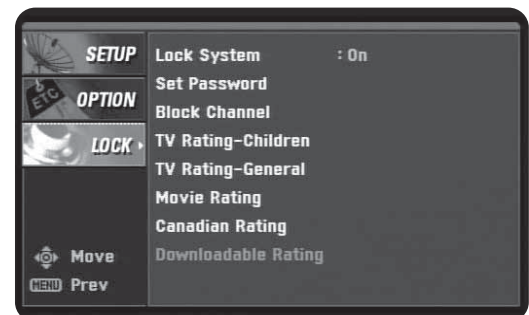

- 4 Press \wedge or \vee to select **Movie Rating**, then press $\>$ or \odot .
- 5 Press \wedge or \vee to select a rating, then press \odot .
 - **G**—General audiences. All ages admitted.
 - **PG**—Parental guidance suggested. May not be suitable for children.
 - **PG-13**—Parental guidance strongly suggested. May not be suitable for children under 13.
 - **R**—Parental guidance recommended for children under 17.
 - **NC-17**—Not suitable for children under 17.
 - **X**—Adults only.

Blocking Canadian programs

To block Canadian programs:

- 1 Press **MENU**. The *SETUP* menu opens.



- 2 Press \wedge or \vee to select **LOCK**, then press $\>$ or \odot .

- Press the number buttons to enter the password. If this is the first time you have accessed the lock system, enter the default password **7777**. The **LOCK** menu opens.

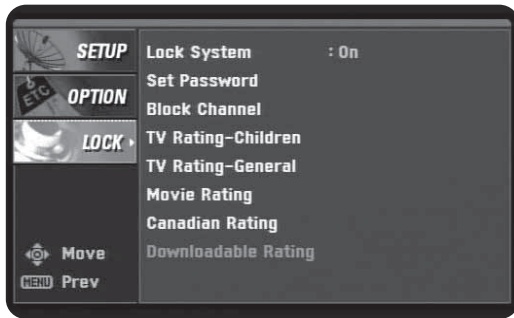

- Press \wedge or \vee to select **Canadian Rating**, then press $\>$ or \odot .
 - Press \wedge or \vee to select **English** or **French**, then press $\>$ or \odot .
- Select **English** for Canadian programs that have English ratings. Select **French** for Canadian programs that have French ratings.
- Select a rating, then press \odot .

For English ratings:

- C**—Programs intended for children under 8.
- C8+**—Programs generally considered acceptable for children 8 and over.
- G**—General audience.
- PG**—Parental guidance.
- 14+**—Programs that contains themes or content which may not be suitable for viewers under 14.
- 18+**—Adult program.

For French ratings:

- G**—General programs intended for audience of all ages.
- 8 ans+**—Not recommended for young children.
- 13 ans+**—Programs may not be suitable for children under 13.
- 16 ans+**—Programs not suitable for children under the age of 16.
- 18 ans+**—Programs restricted to adults.

Downloading rating information

You can update rating information if the station provides downloadable rating information.

To download rating information:

- Press **MENU**. The **SETUP** menu opens.



- Press \wedge or \vee to select **LOCK**, then press $\>$ or \odot .
- Press the number buttons to enter the password. If this is the first time you have accessed the lock system, enter the default password **7777**. The **LOCK** menu opens.

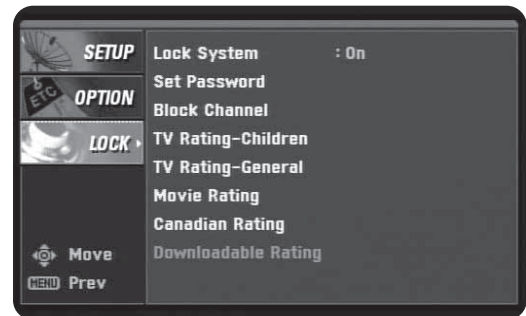

- Press \wedge or \vee to select **Downloadable Rating**, then press $\>$ or \odot .
- Press \wedge or \vee to select a rating title or TV rating, then press $\>$ or \odot .
- Press \wedge or \vee to select a rating, then press \odot .

Notes

- If information is not downloaded from the TV station, the **Downloadable Rating** option is not available.
- Rating information is automatically downloaded while watching DTV channels. It may take several seconds.
- The **Downloadable Rating** option is available for use after rating information is downloaded from the TV station. However, depending on the information from the TV station, it may not be available for use.
- Rating levels differ depending on the broadcasting station.
- The default option name and **Downloadable Rating** changes depending on the downloaded information.
- The on-screen display for **Downloadable Rating** options appear in the language that the TV station sends.
- The rating titles (for example Humor) and TV ratings (for example MH, H, or VH) may differ depending on the TV station.

Using the on-screen menu system

The first time you turn on your converter box, the Install Guide opens, where you can set basic options. For more information, see "Setting basic options" on page 5.

Your converter box has an on-screen menu system that you can use to adjust options such as picture and sound.

To use the on-screen menu system:

- Press **MENU**. The menu system opens.



- Press \wedge or \vee to select a menu, then press $\>$ or \odot to go to the options for the menu you selected.

- 3 Press \wedge or \vee to select an option, then press \gt to go to the next level of options.
- 4 Press \wedge or \vee to adjust the option, then press \odot to confirm your setting.
- 5 Press **EXIT** to close the menu system.

SETUP menu

Note
If the **Lock System** option is turned on, you must enter the password to access the **Auto Tuning** and **Manual Tuning** options. For more information about the **Lock System** option, see "Turning the lock system on or off" on page 11.



OPTION menu

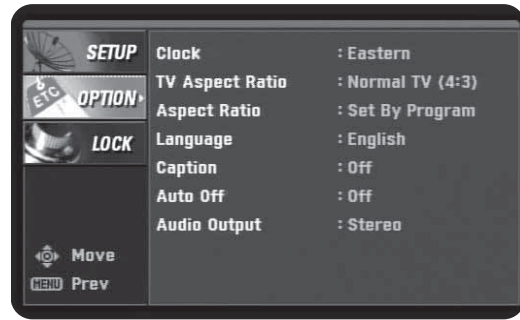

Menu option	Description
Auto Tuning	Automatically finds all digital channels available through the From Antenna jack. For more information, see "Searching for channels" on page 7.
EZ Add	Automatically adds new channels available through the From Antenna jack. Select this option, then press \odot . Your converter box searches for new channels and adds them to the memorized channel list.
Channel Edit	Manually adds or deletes channels from the channel list or the Favorites list. For more information, see "Editing the memorized channel list" on page 8 or "Creating a Favorites list" on page 8.
Manual Tuning	Manually adds channels to the channel list. For more information, see "Editing the memorized channel list" on page 8.
Output Channel	Selects the channel (3 or 4) for the signal from the To TV (RF) jack. Your TV must be tuned to the same channel to display the TV image. For more information, see "Setting the output channel" on page 6.
Install Guide	Lets you quickly adjust basic options. When you select this option the <i>Install Guide</i> opens. For more information, see "Setting basic options" on page 5.

Menu option	Description
Clock	Sets the time. Normally, the clock is set using signals transmitted by digital TV (DTV) stations. When you select a time zone, the clock is set automatically. Note: If the DTV station does not send a time signal or sends the wrong time signal, the clock may be set to an incorrect time. For more information, see "Setting the clock" on page 9.
TV Aspect Ratio	Selects your TV type. Select 4:3 if your TV has a standard screen. Select 16:9 if your TV has a wide screen. For more information, see "Selecting the TV type" on page 9.
Aspect Ratio	Selects the screen format for the current channel. The aspect ratio options you can select vary depending on the TV aspect ratio you select. While watching TV, you can change the aspect ratio by pressing ZOOM . If the aspect ratio is set by the program and cannot be changed, this option will be greyed and display the message "Set by Program." For more information, see "Selecting the TV program aspect ratio" on page 9.
Language	Select the language for the audio and menus. You can select English , Spanish , or French . You can select one language for audio and a different language for menus.
Caption	Selects the type of closed captions that are displayed and changes the appearance of closed captions. For more information, see "Controlling closed captions" on page 11.
Auto Off	Sets the amount of time your converter box waits before it automatically turns off the TV. The default amount of time is four hours. You can also set the Auto Off time by pressing SLEEP . For more information, see "Setting the Sleep timer" on page 10.
Audio Output	Selects the audio output mode for the R AUDIO and L AUDIO jacks. Select Stereo if the TV is connected with a stereo audio (left/right) cable. Select Mono if the TV is connected with a mono cable or coaxial cable.

LOCK menu

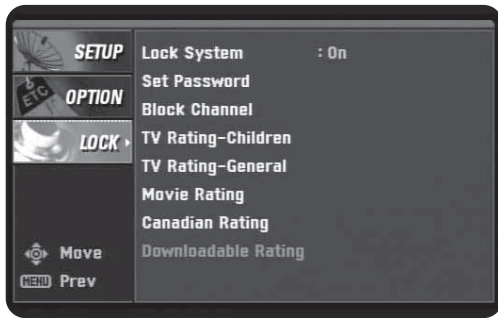

Menu option	Description
Lock System	Turns the lock system on or off. For more information, see “Turning the lock system on or off” on page 11.
Set Password	Sets or changes the password. For more information, see “Changing the password” on page 11. The default password is 7777 .
Block Channel	Blocks or unblocks any channel you do not want to view. If you tune to a blocked channel, a blank screen appears with a blinking CH BLOCKED banner. For more information, see “Blocking channels” on page 12.
TV Rating-Children	Blocks or unblocks children’s TV programs based on ratings. This option only applies to children’s TV programs. To block TV programs intended for mature audiences, you must set the TV Rating-General option. For more information, see “Blocking children’s TV programs” on page 12.
TV Rating-General	Blocks or unblocks TV programs based on ratings. For more information, see “Blocking general TV programs” on page 13.
Movie Rating	Blocks movies based on their ratings. For more information, see “Blocking movies” on page 13.
Canadian Rating	Blocks or unblocks TV programs based on Canadian ratings.
Downloadable Rating	Automatically downloads rating information from DTV stations. For more information, see “Downloading rating information” on page 14.

Programming the converter box remote control

You can control the power button on the TV with the supplied remote control. To do this, you need to program the remote control.

To program the remote control:

- 1 Determine if the TV is a model that can be controlled by the remote control. See “Controllable TV brands” on page 17.
- 2 Turn on the TV.
- 3 While you press and hold **TV POWER** on the remote control, press **CH ^** or **CH v** one or more times until the TV turns off. Each time you press one of these buttons, the remote control sends a manufacturer code (between 1 and 45) to the TV.

Programming a universal remote control

If you have a universal remote control, you can use it to control your converter box.

To program a universal remote control:

- 1 Turn on your converter box.
- 2 Find the program code for LG or Zenith set-top boxes in the documentation that came with the universal remote control.
- 3 Follow the instructions that came with the universal remote control to enter the manufacturer code for an LG or Zenith set-top box.

Controllable TV brands

Abex	CXC	Jensen	Optimus	Simpson
Admiral	Daewoo	JVC	Orion	Sony
Advent	Durabrand	KEC	Panasonic	Soundesign
Aiko	Electroband	Kenwood	Penney	Squareview
Akai	Elektra	KLH	Philco	SSS
America Action	Emerson	KTV	Philips	Starlite
Anam	Envision	LG	Pilot	Supreme
Anam National	Fisher	Lloyd's	Poptonica	SVA
AOC	Funai	LXI	Portland	Sylvania
Apex Digital	Futuretech	Magnasonic	Prima	Symphonic
Audiovox	GE	Magnavox	Prism	Tandy
Baysonic	Gibraltar	Magnin	Proscan	Tatung
Bell&Howell	GoldStar	Marantz	Proton	Technics
Bradford	Grunpy	Masushita	Quasar	Techwood
Broksonic	Haier	Megatron	RadioShack	Teknika
Candle	Hallmark	Memorex	RCA	Thomas
Carnivale	Harley Davidson	MGA	Realistic	TMK
Carver	Harman/Kardon	Midland	Runco	Toshiba
Celebrity	Harvard	Mitsubishi	Sampo	Totevision
Celera	Havermy	Motorola	Samsung	TVS
Changhong	Hello Kitty	MTC	Samsux	Vector Research
Citizen	Himitsy	Multitech	Sansui	Victor
Clarion	Hisense	NAD	Sanyo	Vidikron
Contec	Hitachi	NEC	Scotch	Vidtech
Craig	Infinity	Nikko	Scott	Wards
Crosley	Insignia	Norcent	Sears	White Westinghouse
Crown	JBL	NTC	Sharp	Yamaha
Curtis Mathes	JCB	Onwa	Sheng Chia	Zenith

Troubleshooting

Insignia has detailed information about troubleshooting problems on its Web site at:
www.insignia-products.com/t-frequently_asked_questions.aspx

Problem	Solution
No power.	<ul style="list-style-type: none"> Make sure that the power cord is plugged securely into a power outlet.
Fragmented picture and unclear sound.	<ul style="list-style-type: none"> Check your antenna input, location, and signal strength.
No picture.	<ul style="list-style-type: none"> Select the Auto Tuning or Manual Scan functions, if you have not already done so. Make sure that all the cables are installed correctly and that the correct source is selected on your TV (for example, CH 3, CH 4, Video 1, or Video 2). The antenna signal strength may be low. Check the signal strength and adjust the antenna location and direction. <p>For more information about connections, see "Connecting an antenna" on page 5.</p>
Normal picture but no sound.	<ul style="list-style-type: none"> Check volume levels. Make sure that the TV sound is not muted. Make sure that the your converter box is connected correctly.
Picture is distorted.	<ul style="list-style-type: none"> Make sure that the correct aspect ratio is selected. Make sure that the video output is connected to the TV.
Available channels are missing.	<ul style="list-style-type: none"> You can find all the available channels by running the Auto Tuning or EZ Add in the on-screen menu system. Adjust the antenna. Check the antenna's signal strength.
You forgot your password.	Enter the master password 7777 .
The remote control does not work correctly.	<ul style="list-style-type: none"> Point the remote control at the remote sensor on your converter box. Operate the remote control within 23 feet (7 meters) of the remote sensor. Remove any obstacles between the remote control and the remote sensor. Replace dead batteries with new ones.

Specifications

Design and specifications are subject to change without prior notice.

General

Television system	DTV standard ATSC
Channel coverage	Terrestrial 2-69
Dimensions (W × H × D)	Approximately 8.5 × 1.8 × 6.4 inches (215 × 46 × 162 mm)
Net weight	Approximately 1.65 lbs. (0.75 kg)
Operating temperature	41°F to 104°F (5°C to 40°C)
Operating humidity	5% to 90%
Power requirement	120V 60 Hz AC

Power consumption	7 W
-------------------	-----

Input/output

Antenna in (From Antenna)	Antenna input, ATSC, 75 ohms
Antenna out (To TV (RF))	Antenna output, 75 ohms, RF output channel 3 or 4 (switchable)
Video output	1.0 V (p-p), 75 ohms, negative sync, RCA jack (1)
Audio output	2.0 Vrms (1 KHz, 0 dB), 600 ohms, RCA jack (L, R) (1)

Legal notices

FCC warning

This equipment may generate or use radio frequency energy. Changes or modifications to this equipment may cause harmful interference unless the modifications are expressly approved in the instruction manual. The user could lose the authority to operate this equipment if an unauthorized change or modification is made.

FCC Part 15

This equipment has been tested and found to comply with the limits for a Class B digital device, pursuant to Part 15 of the FCC Rules. These limits are designed to provide reasonable protection against harmful interference when the product is operated in a residential installation. This product generates, uses, and can radiate radio frequency energy and, if not installed and used in accordance with the instruction manual, may cause harmful interference to radio communications. However, there is no guarantee that interference will not occur in a particular installation. If this product does cause harmful interference to radio or television reception, which can be determined by turning the product off and on, the user is encouraged to try to correct the interference by one or more of the following measures:

- Reorient or relocate the receiving antenna.
- Increase the separation between the product and receiver.
- Connect the product into an outlet on a circuit different from that to which the receiver is connected.
- Consult the dealer or an experienced radio/TV technician for help.

Warning

Do not attempt to modify your converter box in any way without written authorization from Insignia. Unauthorized modification could void the user's authority to operate this product.

Your converter box is intended to receive and decode signals transmitted according to the ATSC Digital Television Standard A/53 specification and is intended to be used with an appropriate antenna and display device that you must provide.

Energy Star®



As an Energy Star Partner, Insignia has determined that this product or product models meet the Energy Star guidelines for energy efficiency.

90-day limited warranty

Insignia Products ("Insignia") warrants to you, the original purchaser of this new **NS-DXA1-APT** ("Product"), that the Product shall be free of defects in the original manufacture of the material or workmanship for a period of 90 days from the date of your purchase of the Product ("Warranty Period"). This Product must be purchased from an authorized dealer of Insignia brand products and packaged with this warranty statement. This warranty does not cover refurbished Product. If you notify Insignia during the Warranty Period of a defect covered by this warranty that requires service, terms of this warranty apply.

How long does the coverage last?

The Warranty Period lasts for 90 days from the date you purchased the Product. The purchase date is printed on the receipt you received with the Product.

What does this warranty cover?

During the Warranty Period, if the original manufacture of the material or workmanship of the Product is determined to be defective by an authorized Insignia repair center or store personnel, Insignia will (at its sole option): (1) repair the Product with new or rebuilt parts; or (2) replace the Product at no charge with new or rebuilt comparable products or parts. Products and parts replaced under this warranty become the property of Insignia and are not returned to you. If service of Products or parts are required after the Warranty Period expires, you must pay all labor and parts charges. This warranty lasts as long as you own your Insignia Product during the Warranty Period. Warranty coverage terminates if you sell or otherwise transfer the Product.

How to obtain warranty service?

If you purchased the Product at a retail store location, take your original receipt and the Product to the store you purchased it from. Make sure that you place the Product in its original packaging or packaging that provides the same amount of protection as the original packaging. If you purchased the Product from an online web site, mail your original receipt and the Product to the address listed on the web site. Make sure that you put the Product in its original packaging or packaging that provides the same amount of protection as the original packaging.

To obtain in-home warranty service for a television with a screen 25 inches or larger, call 1-888-BESTBUY. Call agents will diagnose and correct the issue over the phone or will have an Insignia-approved repair person dispatched to your home.

Where is the warranty valid?

This warranty is valid only to the original purchaser of the product in the United States and Canada.

What does the warranty not cover?

This warranty does not cover:

- Customer instruction
- Installation
- Set up adjustments
- Cosmetic damage
- Damage due to acts of God, such as lightning strikes
- Accident
- Misuse
- Abuse
- Negligence
- Commercial use
- Modification of any part of the Product, including the antenna
- Plasma display panel damaged by static (non-moving) images applied for lengthy periods (burn-in).

This warranty also does not cover:

- Damage due to incorrect operation or maintenance
- Connection to an incorrect voltage supply
- Attempted repair by anyone other than a facility authorized by Insignia to service the Product
- Products sold as is or with all faults
- Consumables, such as fuses or batteries
- Products where the factory applied serial number has been altered or removed

REPAIR REPLACEMENT AS PROVIDED UNDER THIS WARRANTY IS YOUR EXCLUSIVE REMEDY. INSIGNIA SHALL NOT BE LIABLE FOR ANY INCIDENTAL OR CONSEQUENTIAL DAMAGES FOR THE BREACH OF ANY EXPRESS OR IMPLIED WARRANTY ON THIS PRODUCT, INCLUDING, BUT NOT LIMITED TO, LOST DATA, LOSS OF USE OF YOUR PRODUCT, LOST BUSINESS OR LOST PROFITS. INSIGNIA PRODUCTS MAKES NO OTHER EXPRESS WARRANTIES WITH RESPECT TO THE PRODUCT, ALL EXPRESS AND IMPLIED WARRANTIES FOR THE PRODUCT, INCLUDING, BUT NOT LIMITED TO, ANY IMPLIED WARRANTIES OF AND CONDITIONS OF MERCHANTABILITY AND FITNESS FOR A PARTICULAR PURPOSE, ARE LIMITED IN DURATION TO THE WARRANTY PERIOD SET FORTH ABOVE AND NO WARRANTIES, WHETHER EXPRESS OR IMPLIED, WILL APPLY AFTER THE WARRANTY PERIOD. SOME STATES, PROVINCES AND JURISDICTIONS DO NOT ALLOW LIMITATIONS ON HOW LONG AN IMPLIED WARRANTY LASTS, SO THE ABOVE LIMITATION MAY NOT APPLY TO YOU. THIS WARRANTY GIVES YOU SPECIFIC LEGAL RIGHTS, AND YOU MAY ALSO HAVE OTHER RIGHTS, WHICH VARY FROM STATE TO STATE OR PROVINCE TO PROVINCE.

Contact Insignia:

For customer service please call 1-877-467-4289

www.insignia-products.com

INSIGNIA™ is a trademark of Best Buy Enterprise Services, Inc.

Distributed by Best Buy Purchasing, LLC.

Insignia, 7601 Penn Avenue South, Richfield, Minnesota, U.S.A.



www.insignia-products.com (877) 467-4289

Distributed by Best Buy Purchasing, LLC
7601 Penn Avenue South, Richfield, MN USA 55423-3645
© 2008 Best Buy Enterprise Services, Inc.

All rights reserved. INSIGNIA is a trademark of Best Buy Enterprise Services, Inc. Registered in some countries.
All other products and brand names are trademarks of their respective owners.